

# Installation AV LYFT-SKJUTDÖRR

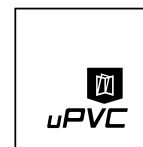

## Verktyg:

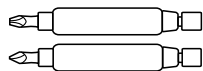

1. Magnetiska skruvbits



2. Borr Ø6, Ø13



3. Batteridrivna skruvdragare

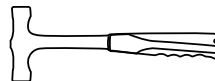

4. Lätt hammare



5. Vrid skruven

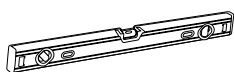

6. Vattenpass

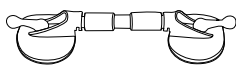

7. Vakuumliftnare

## Material:

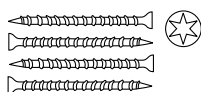

1. Installations-skrudar



2. Kilar



3. Bärklossar

## Steg 1

Ta ut gliddelen

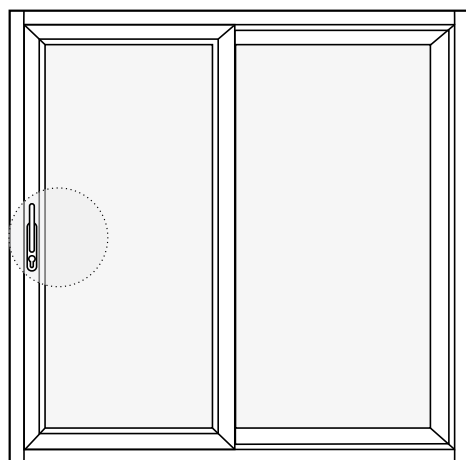

**A** Öppna glid delen: tryck ner handtaget

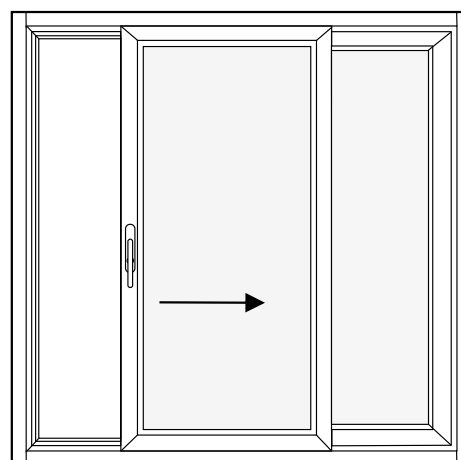
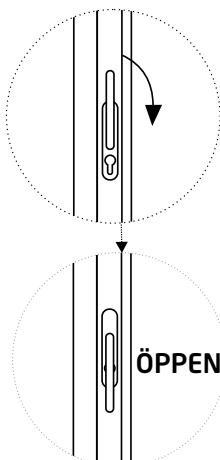

**B** Skjut glid delen mot mitten

# Installation AV LYFT-SKJUTDÖRR

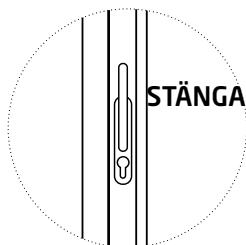
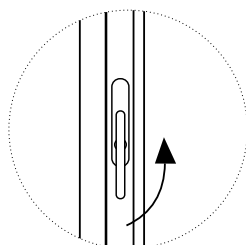
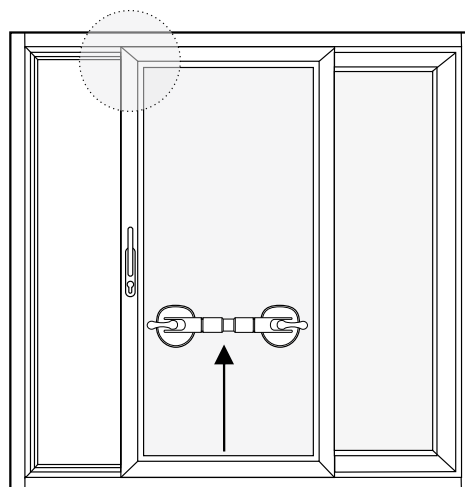
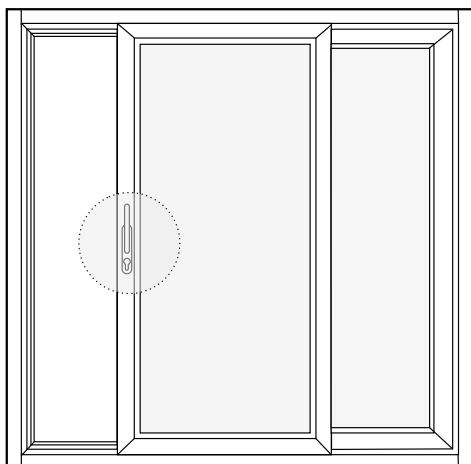
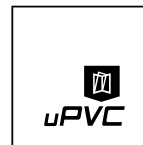

**C** Stäng glid delen

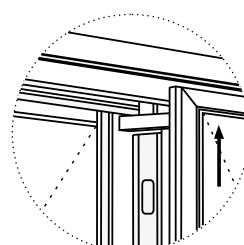

**D** Lyft upp glid delen med vakuumlyftaren

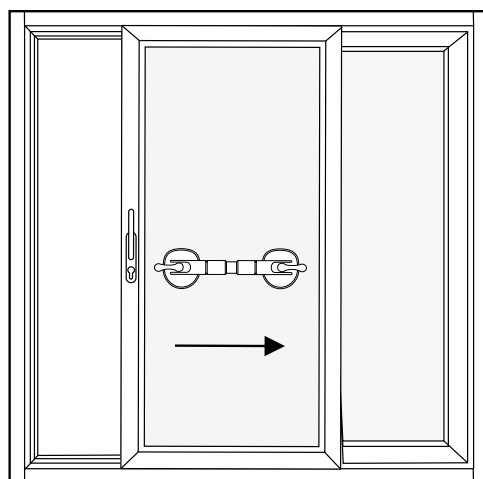

**E** Dra ut den nedre delen av glid delen och ta bort den helt.

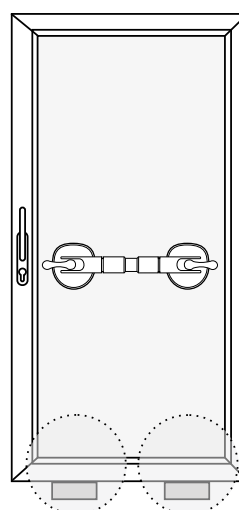

**F** Placera glid delen på stödblocken i en vertikal position.

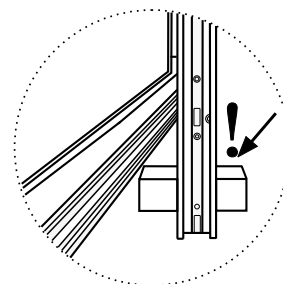

# Installation

## AV LYFT-SKJUTDÖRR

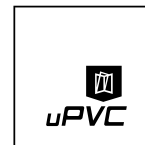

### Steg 2

Ta bort profilskydden.

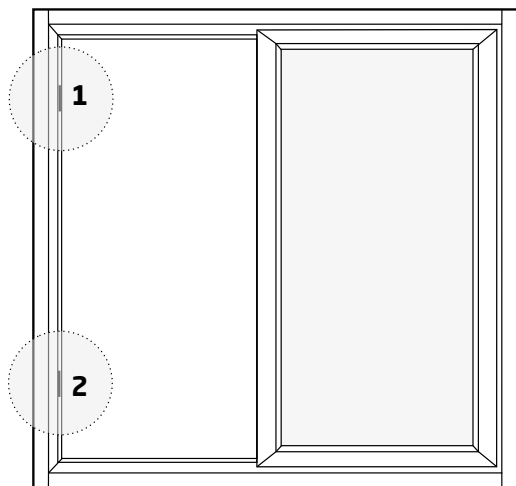

**A** Skruva loss beslagen på öppningssidan.

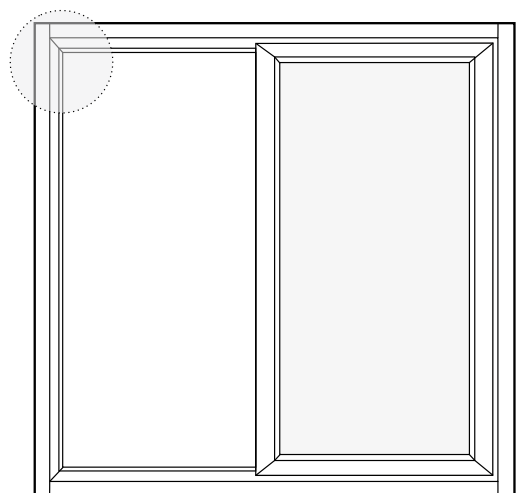
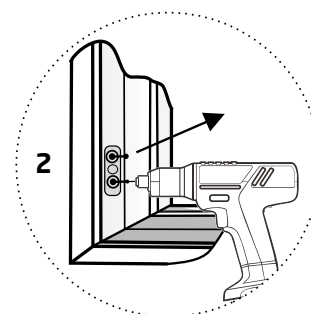
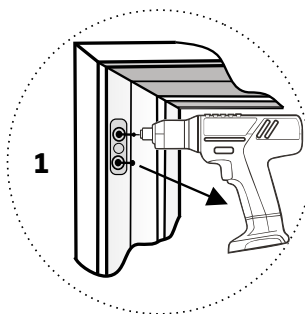

**B** Tryck mejseln bakom profilskydden.

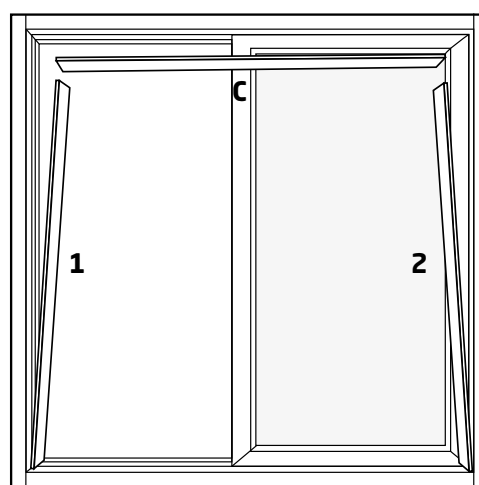

**C** Ta bort profilskydden i följande ordning:  
Från vänster (A), höger (B), övre (C)

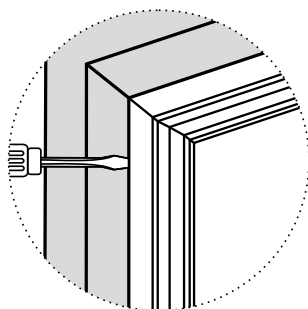

# Installation

## AV LYFT-SKJUTDÖRR

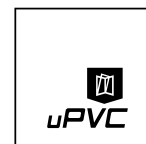

### Steg 3

Fixering i installationsöppningen.

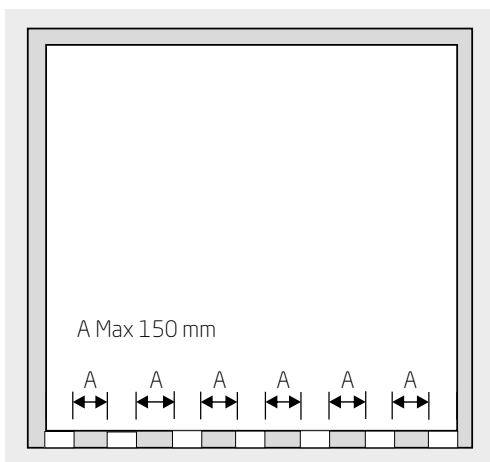

**A** Nivellera basen med hjälp av stödblocken.

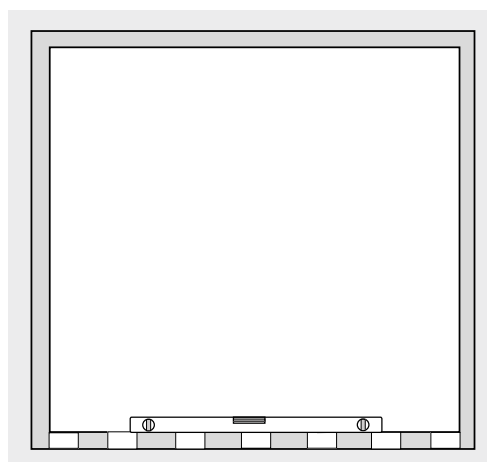

**B** Kontrollera horisontal nivellering med vattenpass. Golvytan måste vara platt.

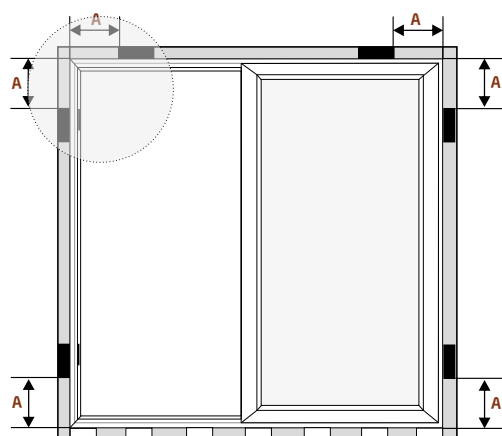

**C** Placera en ram i installationens öppning. Fixera ramen med kilar i alla hörn.

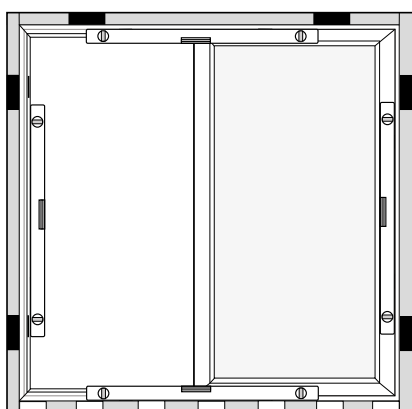

**D** Säkerställ horisontell och vertikal nivellering av ramen med ett vattenpass.

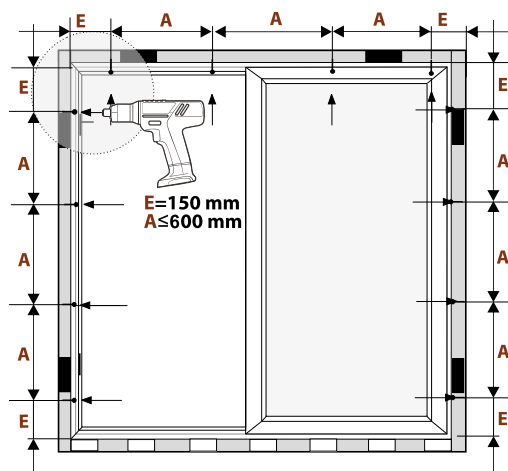
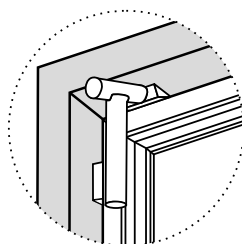

**E** Skruva fast bultarna enligt schemat

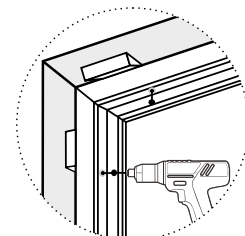

# Installation AV LYFT-SKJUTDÖRR

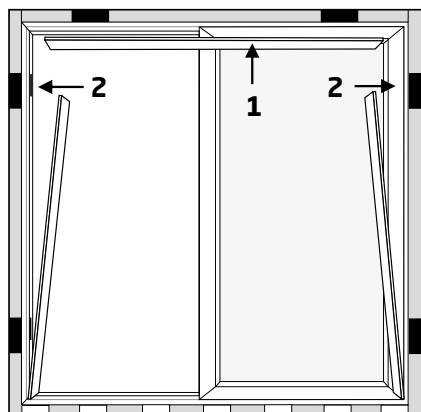

**F** Sätt tillbaka profilskydden (starta med den översta och avsluta med sidorna).

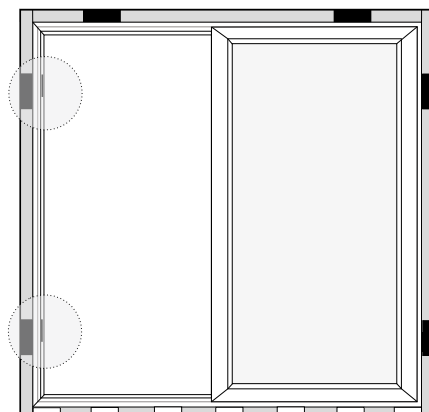

**G** Skruva fast beslagen igen.

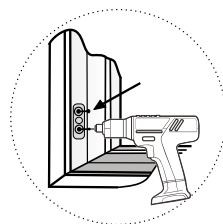
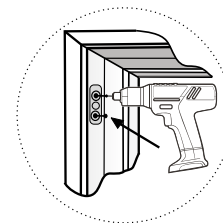

## Steg 4

Sätt tillbaka glid delen.

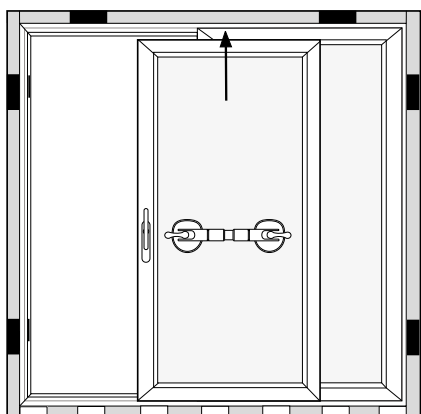

**A** Lyft upp glid delen med en vakuumliftare i vinkel och tryck sen in den nedre delen.

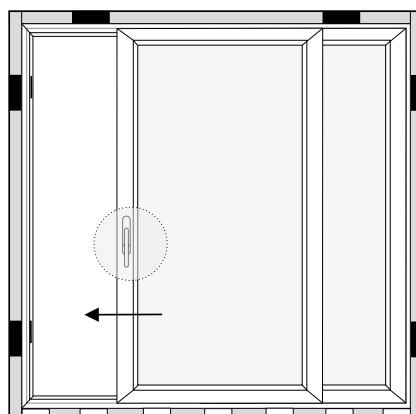

**B** Tryck ner handtaget och flytta fönster-ramen till sidan.

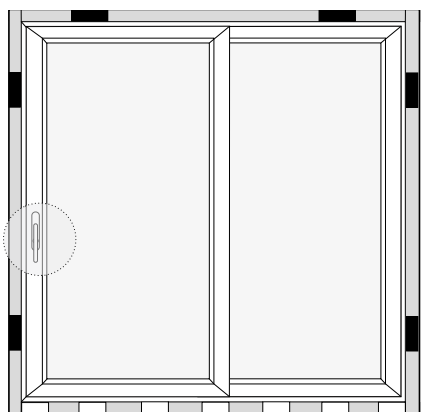
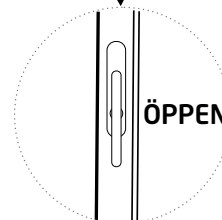
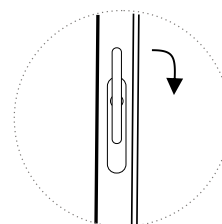

**C** Lyft upp handtaget och kontrollera att allt fungerar korrekt.

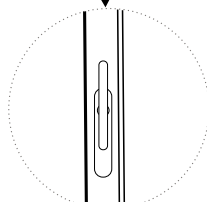
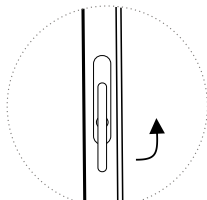

# Installation

## AV LYFT-SKJUTDÖRR

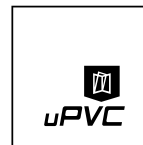

### Steg 5

Slutför installationen.

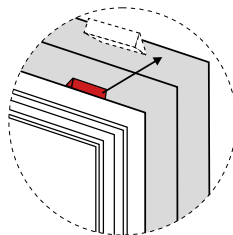
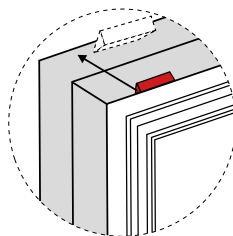
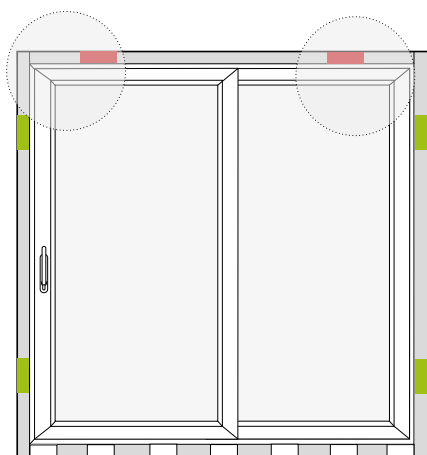

 Lämna  
 Ta bort

**A** Ta ut alla rödmarkerade kilar.

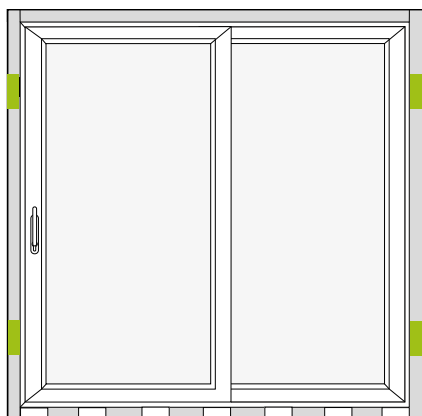

**B** Lyft upp handtaget och kontrollera att allt fungerar korrekt.

### Kontrollera att dörren fungerar efter installationen!

Om fästpunkter är placerade på fel sätt och produkten monteras utanför måttangivelserna, förbehåller NorDan AB sig rätten att inte tillhandahålla garantiservice.